

Selection - PR-AC 254 T

Product Code	7PA2631
Requested Air Volume	1 042 m ³ /h
Requested Pressure	37,2 Pa
Air Volume	1 043 m ³ /h
Static Pressure	37,2 Pa
Total Pressure	58 Pa
Velocity Pressure	21,3 Pa
Outlet Velocity	5,90 m/s
SFP	0,14 W/l/s
Fan Total Efficiency	41,9 %
Fan Static Efficiency	26,7 %
Air Properties	1,22kg/m ³ / 15°C/ 0m/ 50% RH
Motor Input Power	0,040 kW
Temperature Range	-15°C +70°C

Construction Settings

Arrangement	4
Discharge	LG-270
Motor Position	D

Motor Selection

Electrical Supply	400/3/50
Motor Rating	0.12 kW
Enclosure/Class	55 / F
Poles number	4
Motor Speed	1350 rpm
Full Load Current	0.45 A

ERP Information

ERP Compliance	Exempt
Type	
Regulation	-
Category of measure	-

Fan Performance

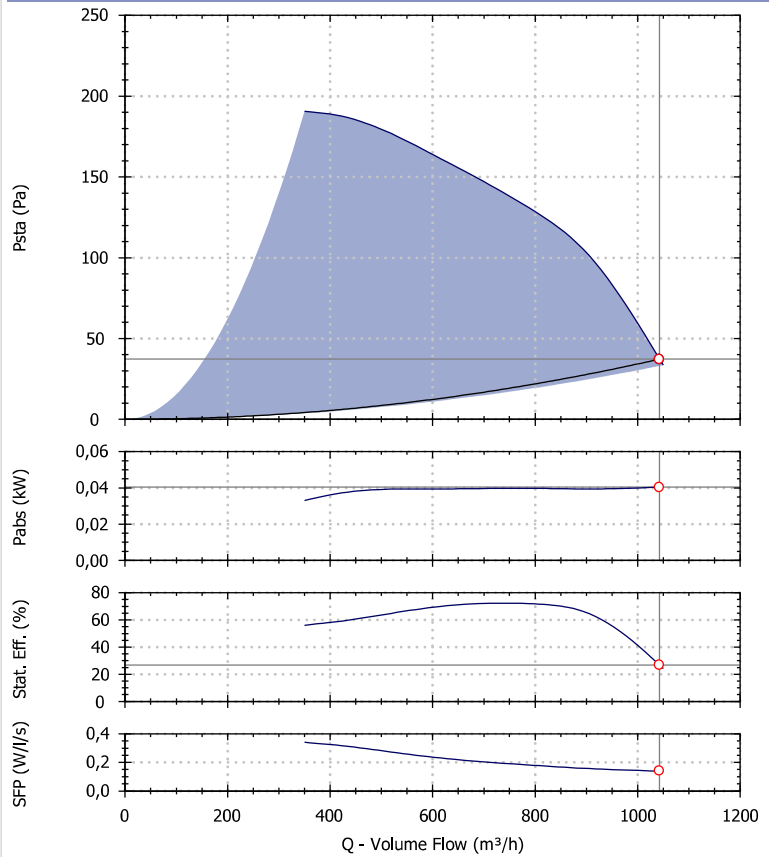

Performances refers to Maico Italia measures and may vary according to the installation type.

Sound Performance

Hz	63	125	250	500	1k	2k	4k	8k	Overall
Lw	55	57	58	53	52	47	39	31	63
Lw(A)	29	41	49	50	52	48	40	30	56
LpA @ 3m	8	20	29	29	31	28	19	9	36

Sounds spectra refers to Maico Italia measures performed in our laboratories. The values provided are just indicative of the situation and Maico Italia declines every responsibility in case different levels measured by our customers as the installation types and the environmental variables may increase/decrease these values.

Drawing and Dimensions - PR-AC 254 T

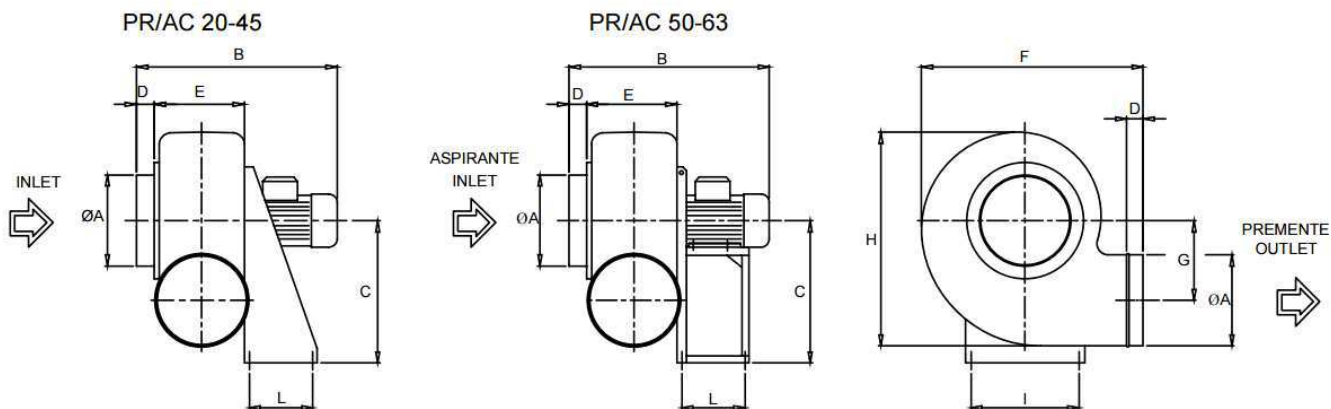

Key	B	C	D	E	F	G	H	I	kg	L	M	N	O	OA
Value [mm]	440	310	30	180	480	183	500	252	12	100	120	250	170	200

Drawings are indicative of the size of the selected fan. These dimensions may vary, even without any explicit advice. To have more accurate information contact your local agency.

Electric Wire Connections

