

Selection - DA 10-8A M

Product Code	1DA0077
Requested Air Volume	0,000 m ³ /h
Requested Pressure	0,000 Pa
Air Volume	0,000 m ³ /h
Static Pressure	0,000 Pa
Total Pressure	0,000 Pa
Velocity Pressure	0,000 Pa
Outlet Velocity	0,00 m/s
Air Temperature	15 °C
Altitude	0 m
Motor Input Power	-
Temperature Range	-20°C +40°C

Fan Performance

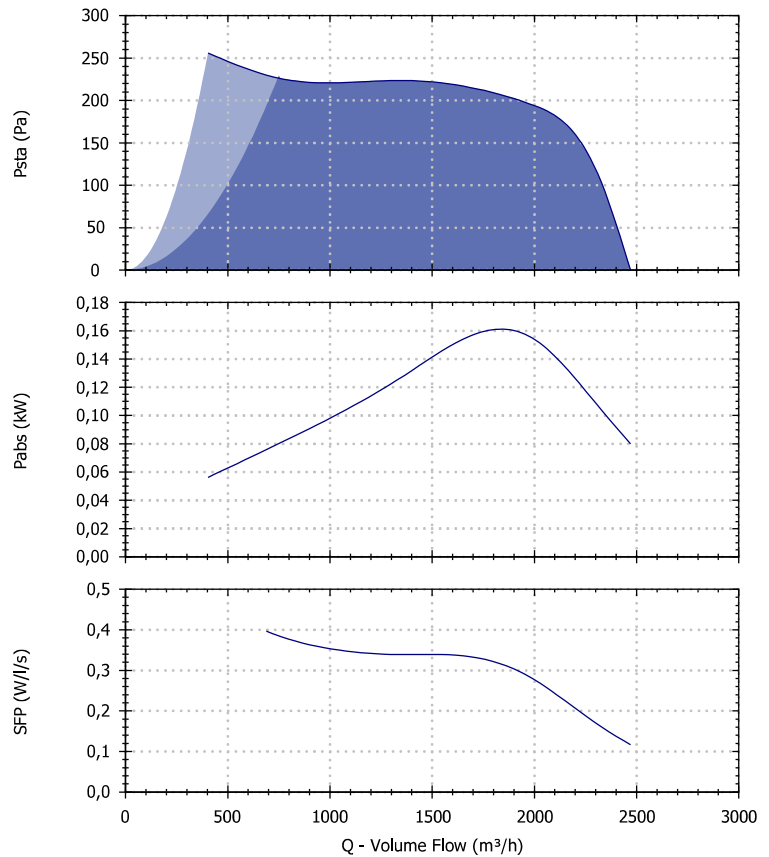

Performances refers to Maico Italia measures and may vary according to the installation type.

Sound Performance

	63	125	250	500	1k	2k	4k	8k	Overall
Lw	73	74	75	77	77	76	73	68	84
Lw(A)	47	58	67	74	77	77	74	67	82
LpA @ 2m	30	41	49	56	60	60	57	50	65

Sounds spectra refers to Maico Italia measures performed in our laboratories. The values provided are just indicative of the situation and Maico Italia declines every responsibility in case different levels measured by our customers as the installation types and the environmental variables may increase/decrease these values.

Selected Accessories

Drawing and Dimensions - DA 10-8A M

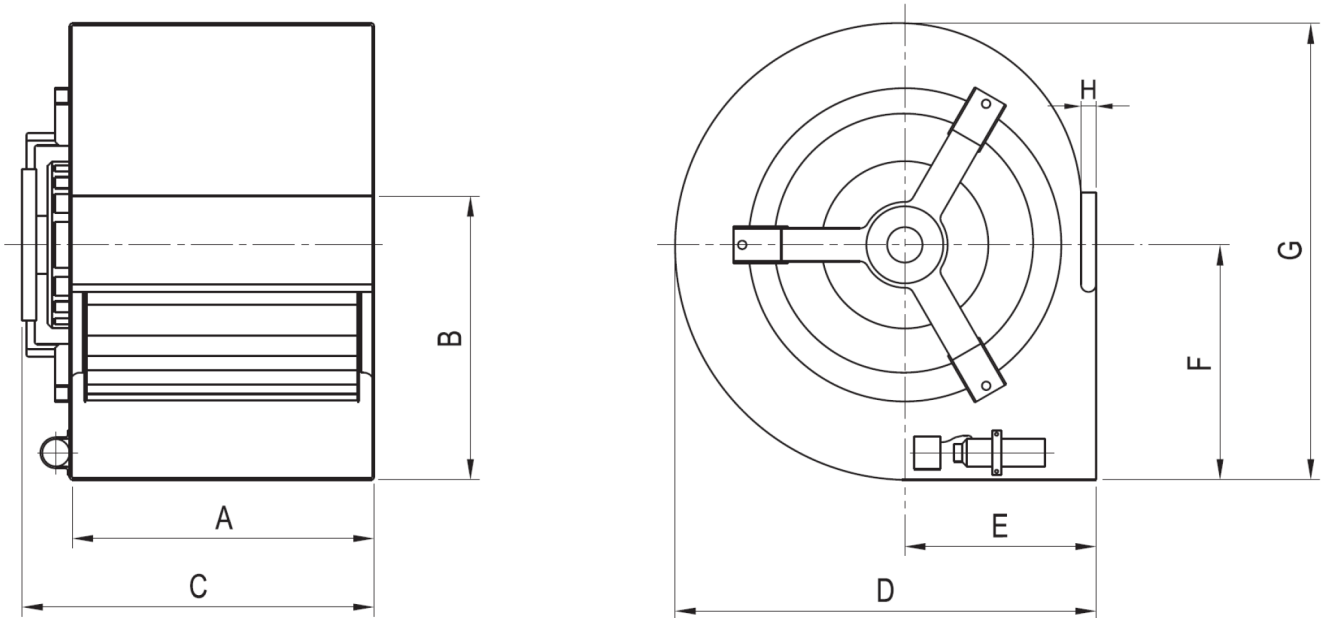

Key	A	B	C	D	E	F	G	H	Kg
Value [mm]	265	290	310	425	200	250	440	40	13

Drawings are indicative of the size of the selected fan. These dimensions may vary, even without any explicit advice. To have more accurate information contact your local agency.